

**Portable Equipment Application.**

**Notebook Application.**

**Features**

- Low  $V_{GS(th)}$  :  $V_{GS(th)} = -0.7 \sim -1.4V$
- Small footprint due to small package
- Low  $R_{DS(ON)}$  :  $R_{DS(ON)} = 61m\Omega$  (Typ.)

**Ordering Information**

Type NO.	Marking	Package Code
STJ004SF	J04	SOT-23F

**Outline Dimensions**

**unit : mm**

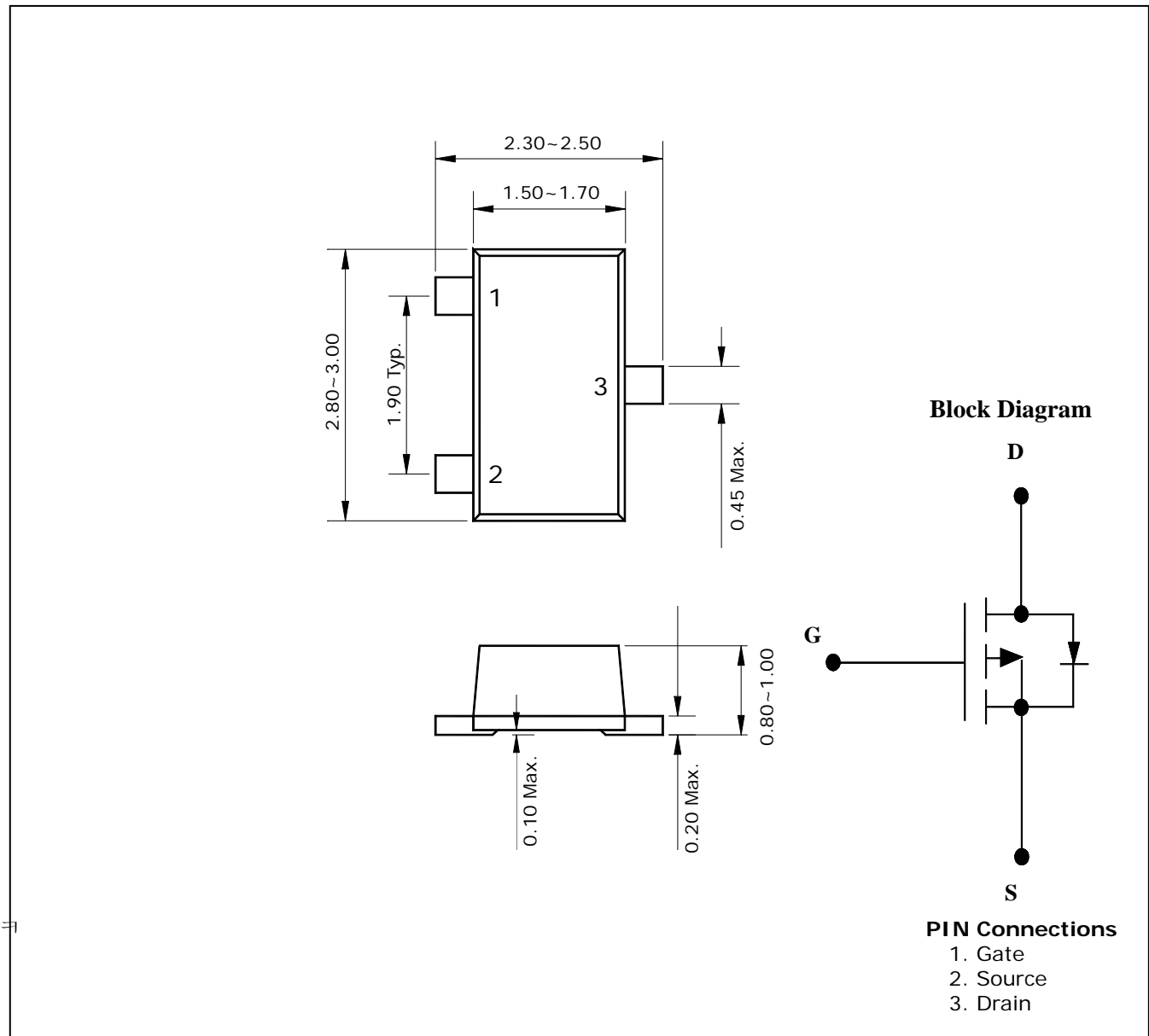

## Absolute maximum ratings

(Ta=25°C)

Characteristic	Symbol	Rating	Unit
Drain-source voltage	$V_{DSS}$	-30	V
Gate-source voltage	$V_{GSS}$	±12	V
Drain current (DC) **	$I_D$	-2.4	A
Drain current (Pulsed) *	$I_{DP}$	-9.6	A
Total Power dissipation **	$P_D$	0.35	W
Avalanche current (Single) ②	$I_{AS}$	-2.4	A
Single pulsed avalanche energy ②	$E_{AS}$	13	mJ
Avalanche current (Repetitive) ①	$I_{AR}$	-2.4	A
Repetitive avalanche energy ①	$E_{AR}$	1.1	mJ
Junction temperature	$T_J$	150	°C
Storage temperature range	$T_{stg}$	-55 ~ 150	

\* Limited by maximum junction temperature

\*\* Device mounted on a glass-epoxy board

Characteristic		Symbol	Typ.	Max	Unit
Thermal resistance	Junction-ambient	$R_{th(J-a)}$ **	-	357	°C/W

## P-CH Electrical Characteristics

(Ta=25°C)

Characteristic	Symbol	Test Condition	Min.	Typ.	Max.	Unit	
Drain-source breakdown voltage	$BV_{DSS}$	$I_D = -250\mu A, V_{GS} = 0$	-30	-	-	V	
Gate threshold voltage	$V_{GS(th)}$	$I_D = -250\mu A, V_{DS} = V_{GS}$	-0.7	-	-1.4	V	
Drain-source cut-off current	$I_{DSS}$	$V_{DS} = -20V, V_{GS} = 0V$	-	-	1	$\mu A$	
Gate leakage current	$I_{GSS}$	$V_{DS} = 0V, V_{GS} = \pm 12V$	-	-	$\pm 100$	nA	
Drain-source on-resistance	$R_{DS(on)}$	$V_{GS} = -4.5V, I_D = -1.2A$	-	61	91	m $\Omega$	
		$V_{GS} = -2.5V, I_D = -1.2A$	-	86	129	m $\Omega$	
Forward transfer conductance ④	$g_{fs}$	$V_{DS} = -5V, I_D = -2.4A$	-	13.2	-	S	
Input capacitance	$C_{iss}$	$V_{GS} = 0V, V_{DS} = -10V,$ $f = 1MHz$	-	398	-	pF	
Output capacitance	$C_{oss}$		-	82	-		
Reverse transfer capacitance	$C_{rss}$		-	46	-		
Turn-on delay time	$t_{d(on)}$	$V_{DD} = -10V, I_D = -2.4A$ $R_G = 10\Omega$	-	11	-	ns	
Rise time	$t_r$		-	5.3	-		
Turn-off delay time	$t_{d(off)}$		③④	-	7.6		-
Fall time	$t_f$		-	5.3	-		
Total gate charge	$Q_g$	$V_{DD} = -10V, V_{GS} = -5V$ $I_D = -2.4A$	-	6.4	9.6	nC	
Gate-source charge	$Q_{gs}$		③④	-	2.8		4.2
Gate-drain charge	$Q_{gd}$		-	1.7	2.6		

## Source-Drain Diode Ratings and Characteristics

(Ta=25°C)

Characteristic	Symbol	Test Condition	Min	Typ	Max	Unit
Source current	$I_S$	Integral reverse diode in the MOSFET	-	-	-0.5	A
Sourcecurrent(Plused) ①	$I_{SM}$		-	-	-2.0	
Forward voltage ④	$V_{SD}$	$V_{GS} = 0V, I_S = -0.5A$	-	-0.7	-1.2	V
Reverse recovery time	$t_{rr}$	$I_S = -2.4A$	-	29	-	ns
Reverse recovery charge	$Q_{rr}$	$di_S/dt = 100A/us$	-	130	-	$\mu C$

Note ;

- ① Repetitive Rating : Pulse Width Limited by Maximum Junction Temperature
- ②  $L=2.0mH, I_{AS}=-2.9A, V_{DD}=-15V, R_G=25\Omega$
- ③ Pulse Test : Pulse Width < 300us, Duty cycle  $\leq 2\%$
- ④ Essentially independent of operating temperature

## P-CH Electrical Characteristic Curves

**Fig. 1  $I_D - V_{DS}$**

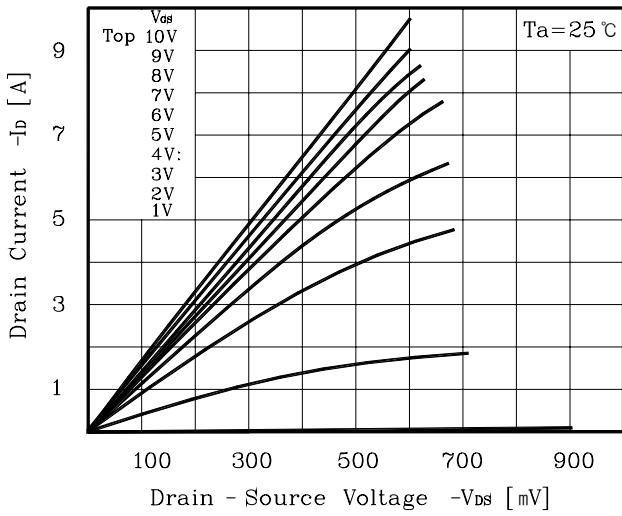

**Fig. 2  $I_D - V_{GS}$**

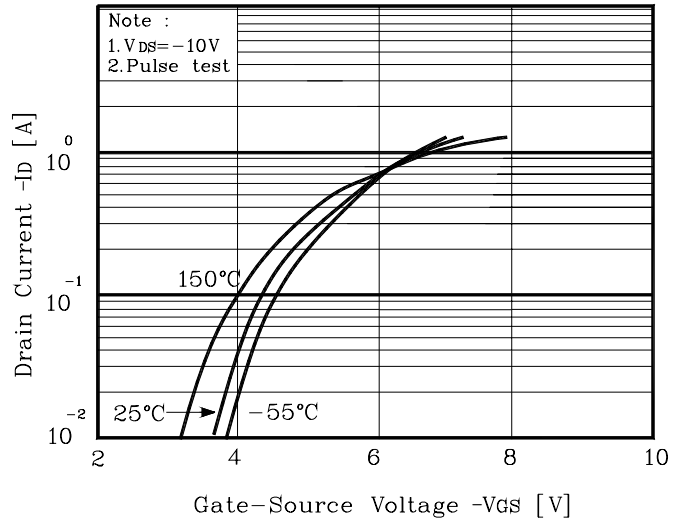

**Fig. 3  $R_{DS(on)} - I_D$**

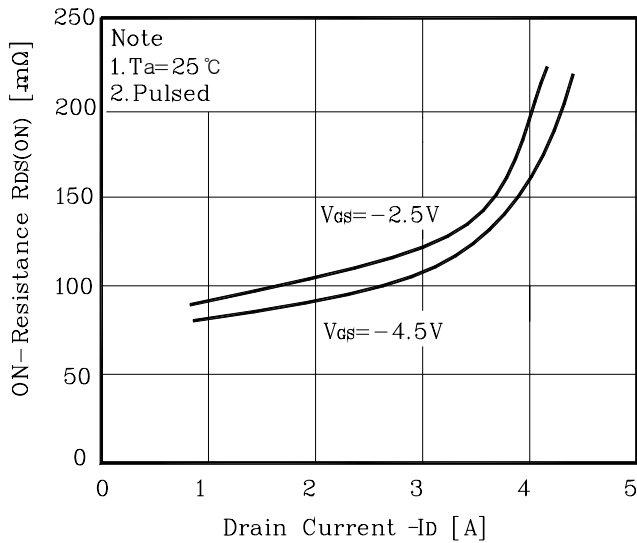

**Fig. 4  $I_S - V_{SD}$**

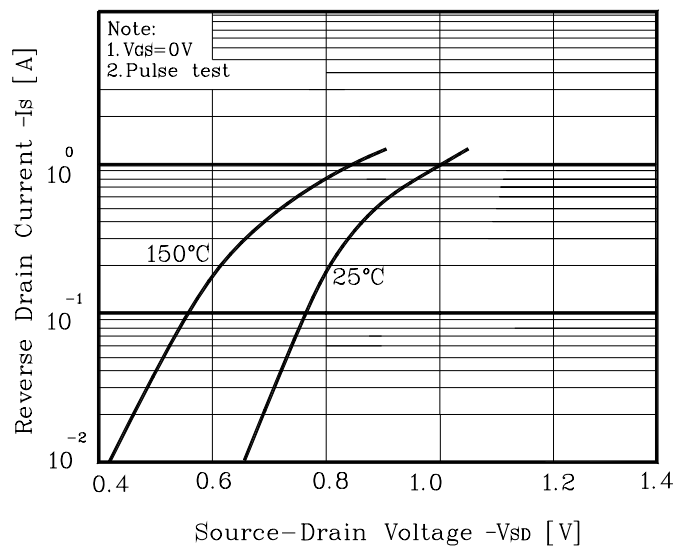

**Fig. 5 Capacitance -  $V_{DS}$**

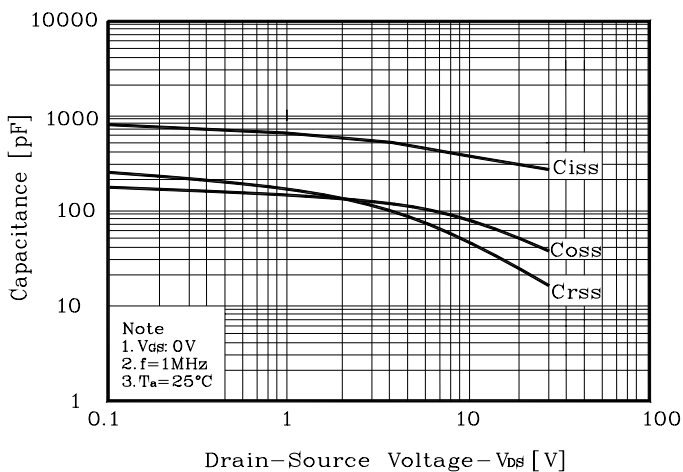

**Fig. 6  $V_{GS} - Q_G$**

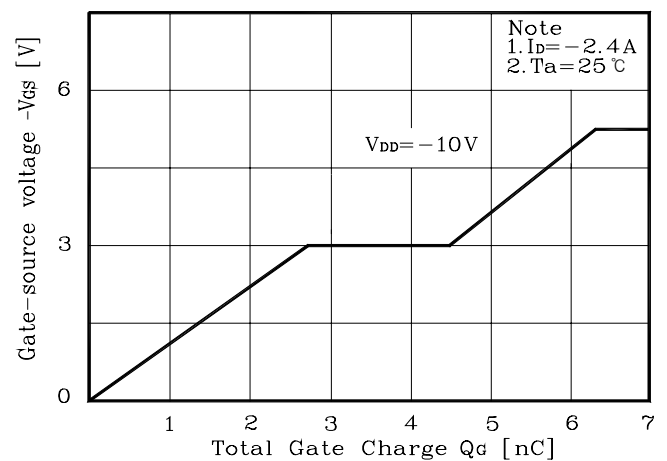

**Fig. 7  $V_{DSS} - T_J$**

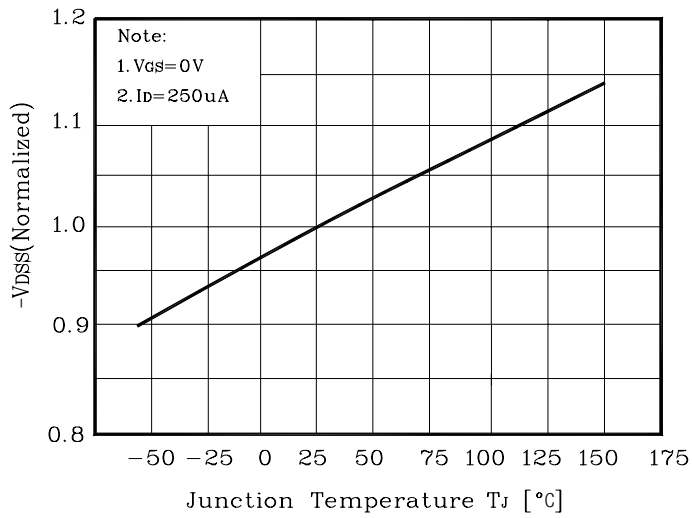

**Fig. 8  $R_{DS(on)} - T_J$**

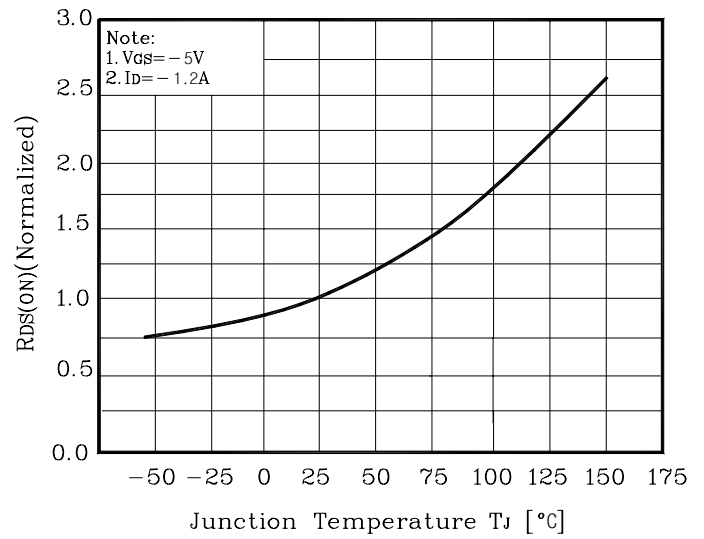

**Fig. 9  $I_D - T_a$**

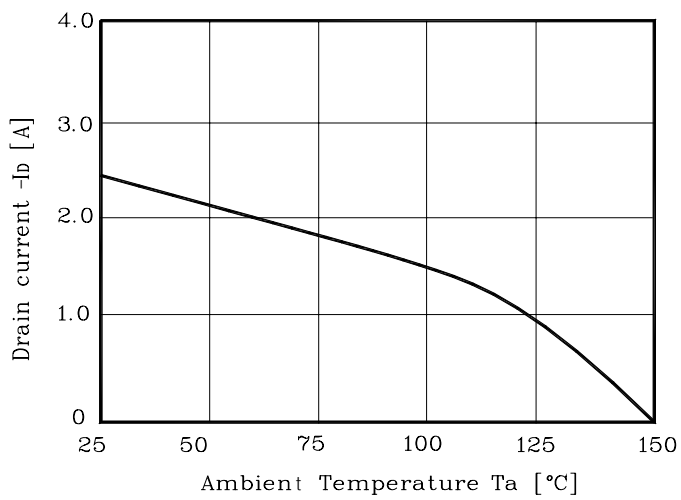

**Fig. 10 Safe Operating Area**

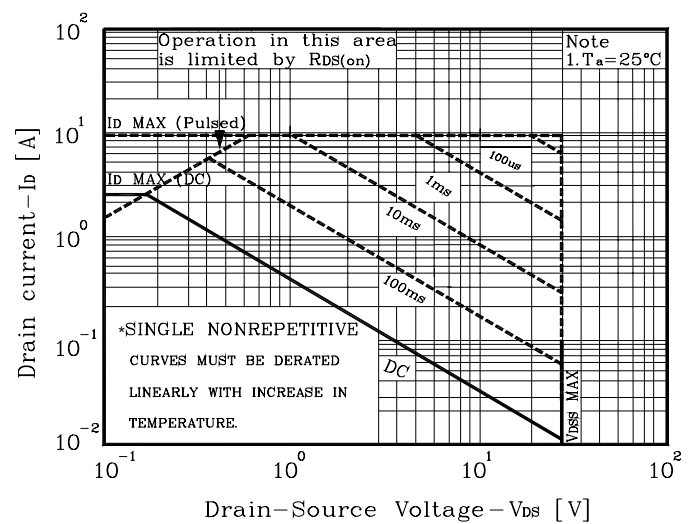

**Fig. 11 Gate Charge Test Circuit & Waveform**

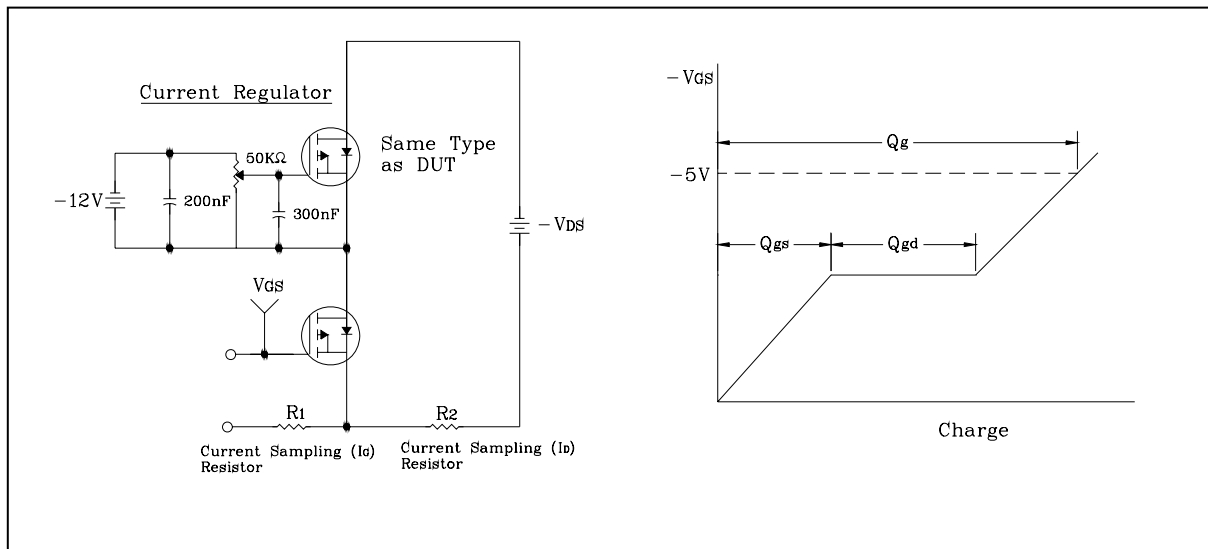

**Fig. 12 Resistive Switching Test Circuit & Waveform**

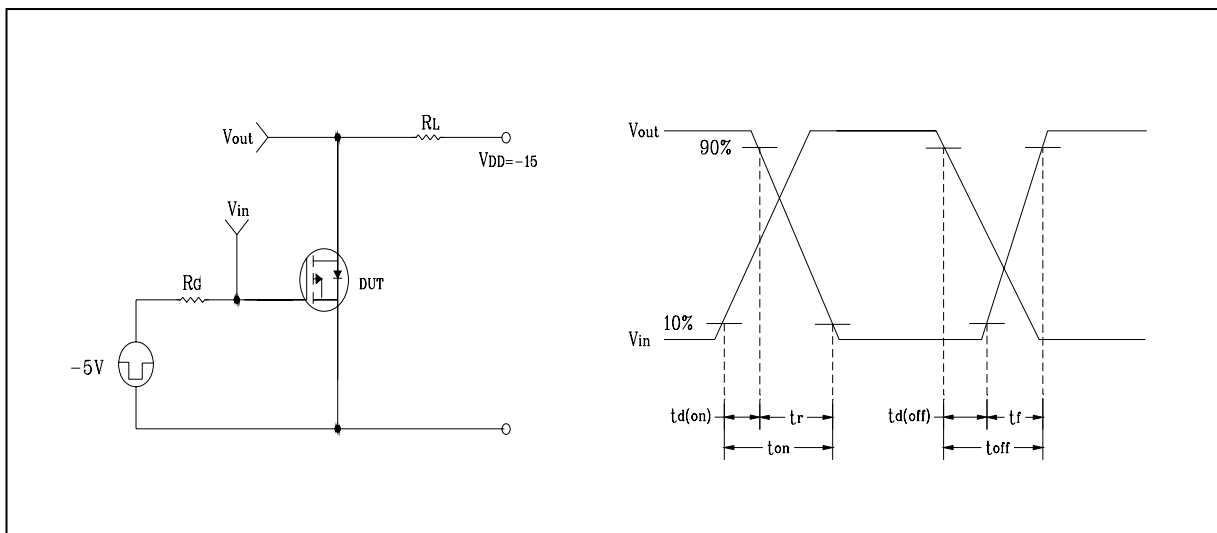

**Fig. 13 EAS Test Circuit & Waveform**

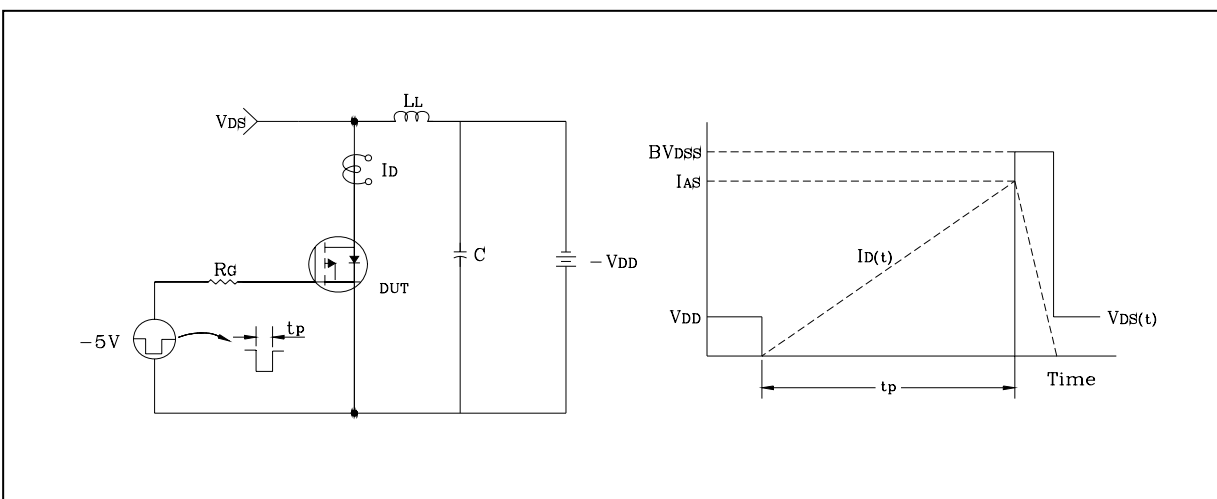
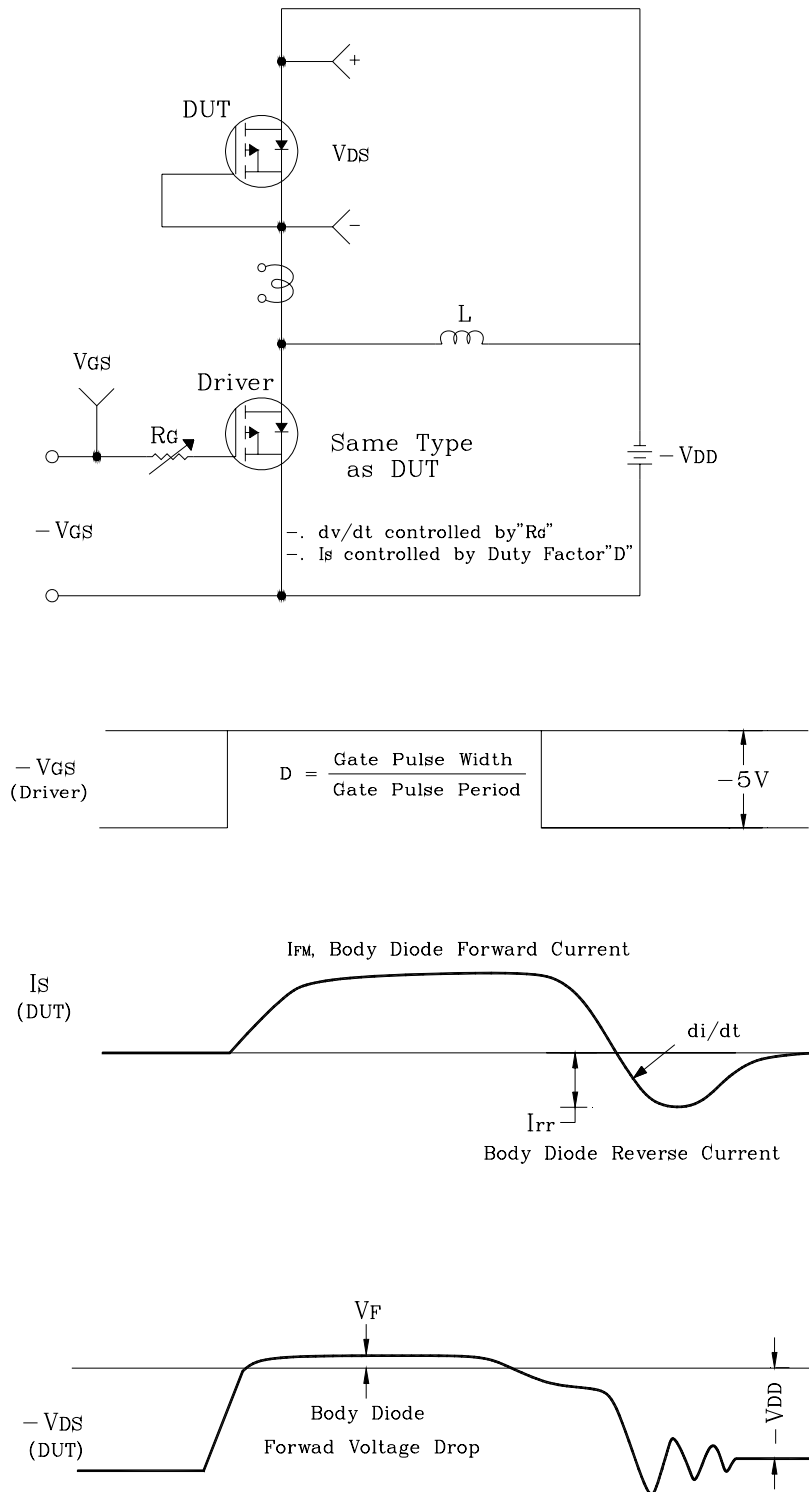

Fig. 14 Diode Reverse Recovery Time Test Circuit & Waveform



**The AUK Corp. products are intended for the use as components in general electronic equipment (Office and communication equipment, measuring equipment, home appliance, etc.).**

**Please make sure that you consult with us before you use these AUK Corp. products in equipments which require high quality and / or reliability, and in equipments which could have major impact to the welfare of human life(atomic energy control, airplane, spaceship, transportation, combustion control, all types of safety device, etc.). AUK Corp. cannot accept liability to any damage which may occur in case these AUK Corp. products were used in the mentioned equipments without prior consultation with AUK Corp..**

**Specifications mentioned in this publication are subject to change without notice.**